

# ***OPTITOME, OXYTOME, PLASMATOME, ALPHATOME AND CYBERTOME***

**NEW  
HPC DIGITAL PROCESS  
OXYCUTTING SYSTEM**

Automatic machines using the plasma and oxycutting processes for high-quality cutting.



# Air Liquide Welding multi-process automatic



For cutting non-alloy or low-alloy steels, stainless steels and/or light alloys, Air Liquide Welding can provide solutions for a wide range of applications. The possibility of combining the numerous processes and their possibilities gives you a wide choice of solutions and diversifications so that you can target your investment to suit your needs.

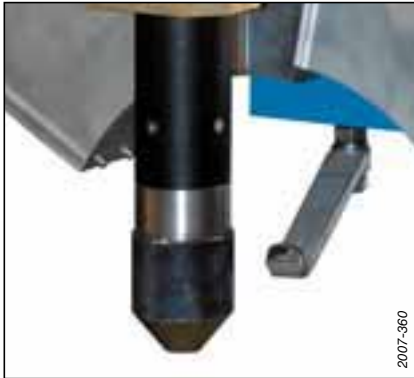

Single or multi-torch HP plasma cutting



Oxycutting

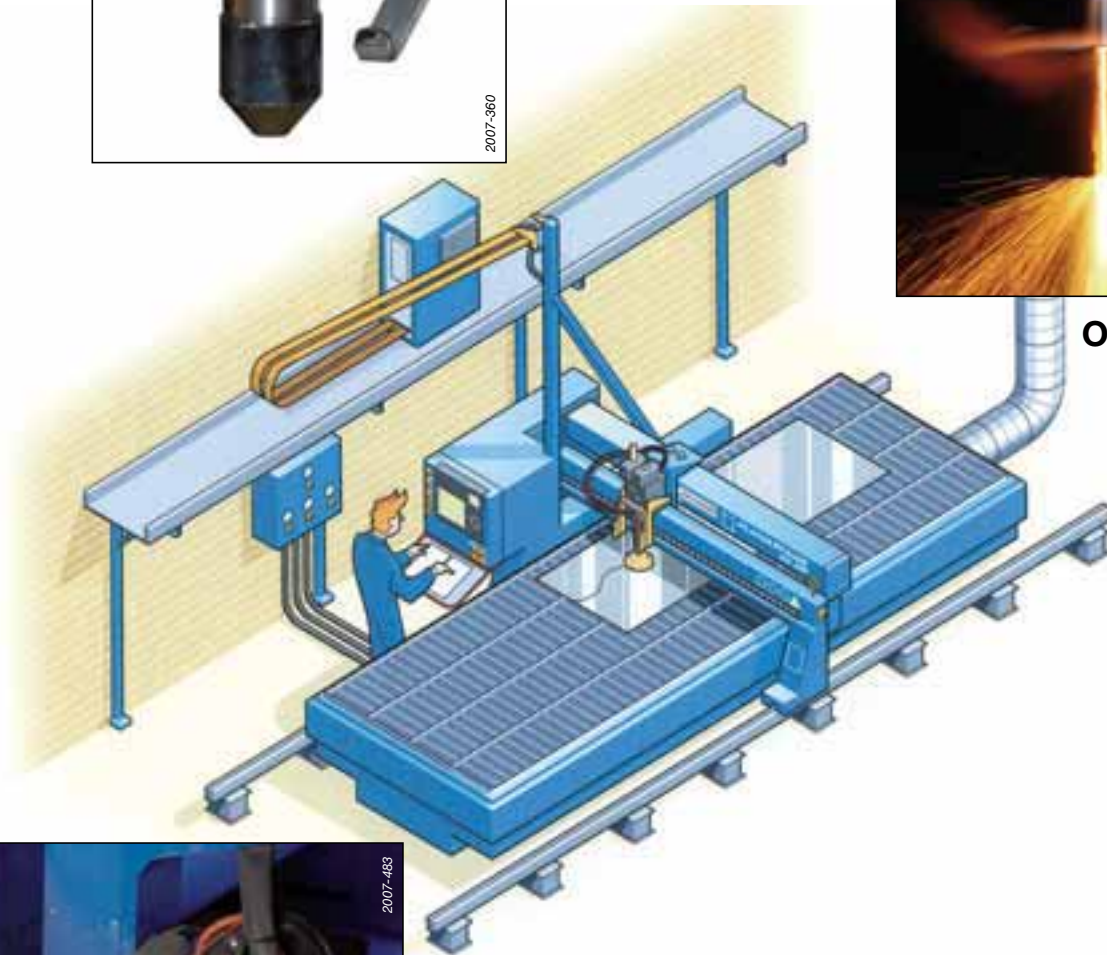

Marking



Plasma beveling unit



Oxycutting beveling unit



cutting solutions.

# Quality and precision

ALPHATOME HPC

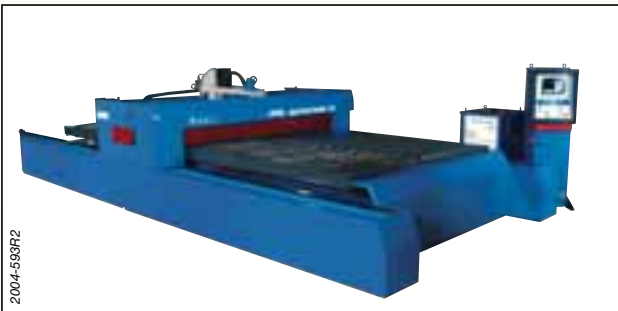

OXYTOME HPC



# Performance and versatility

OXYTOME



PLASMATOME



CYBERTOME



# Competitiveness and cost-effectiveness

OPTITOME 15



# OPTITOME 15



A one-piece plasma cutting machine piloted by digital controls, particularly suited to professions that use steel, stainless steel and aluminium plates measuring 1 500 x 3 000 mm. The main applications concerned are small-scale production, metalwork and locksmithing.

## OPTITOME 15

Has all the qualities required for plasma arc cutting, thanks to its design and the choice of techniques used in its manufacturing.

- Extremely sturdy yet light transverse beam requiring only one high-performance drive system to give optimum cutting,
- Rigid, sturdy frame.

## Exhaust fume extraction table

This sturdy structure has optimized exhaust fume suction that acts over the entire length of the cutting table.

It is independent of the machine frame, thus removing the risk of guides and rails being put out of adjustment.

The cross boxes are mounted on a frame and are removable for easy cleaning.

A second frame can be provided

to make for easier loading and unloading of workpieces. The oxycutting option comes complete with a specially adapted steel metal backing strip.

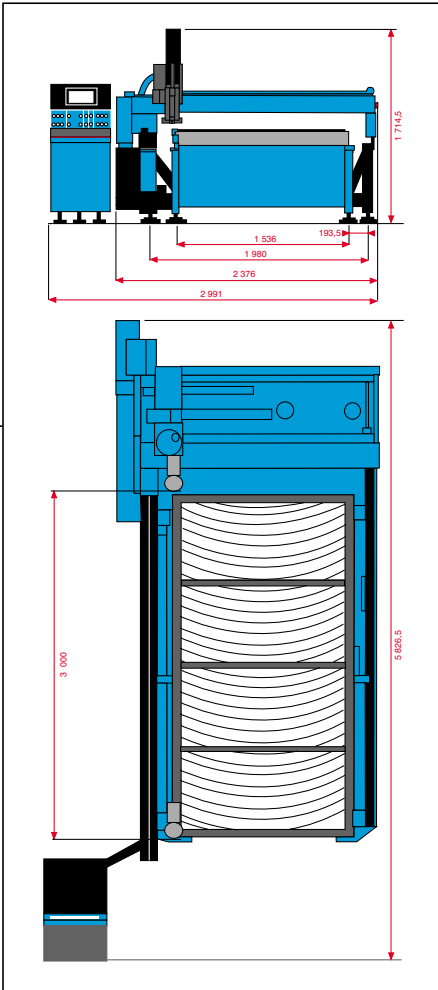

**Designed for the ventilation, air conditioning, sheet metal industries, for small and medium-scale production units, or as an auxiliary unit to boost production when needed. OPTITOME 15 is a one-piece machine designed for easy handling without the need for dismantling, and for easy, quick installation.**

### ■ Marking

On option, the OPTIMOMO 15 can be fitted with 2 different types of marker.

#### • Wen marker



This pneumatic vibrator engraves sheet metal by slightly scoring the surface finish.

#### • Felt marking



This marker uses a felt tip which has been especially selected for its strength. It operates by gravity and does not alter the surface

finish of the material. It is intended for use on galvanized steels, aluminium, stainless and black prepainted steels, depending on the quality of their surface finish. Plasma marking is integrated if the installation is equipped with NERTAJET HP 125 + OCP 150.

### ■ A.C.S. (Anti Crash System)

This feature ensures torch safety and protects the environment from arc emissions. It is fastened independently of the torch to guarantee its vertical alignment after startup.

### ■ Oxycutting

Designed to cut carbon steels up to 50 mm thick.

To increase the versatility of the OPTIMOME 15, this machine can be fitted with an oxycutting option. This option mainly includes:

- 1 blowtorch
- 1 gas pressure adjustment table
- 1 blowtorch holder



- 1 additional exhaust fume extraction table
- 1 soft start arcing system with heating and overheating controls.

## Two possible plasma equipment configurations:

- NERTAJET HP 125 plus OCP 150,
- NERTAJET 50 plus CPM 15



# OXYTOME / PLASMATOME : for perfect plas



The OXYTOME / PLASMATOME range integrates all the features required to implement the plasma and/or oxycutting process.

Fitted with a tool holder with 150 mm travel in oxycutting and 250 mm travel in plasma, these machines can adapt to suit the needs of all trades, and have a cutting potential ranging from the thinnest (0.65 mm) to the thickest possible thicknesses for plasma and/or oxycutting. Their concept: versatility and a wide choice of:

#### ■ Systems:

From the single-torch NERTAJET 50 to the two-torch NERTAJET HP 720.

#### ■ Applications:

0.5 mm thick non-alloy steels /  
300 mm thick low-alloy steels  
or 150 mm thick light alloys /  
150 mm thick stainless steels.

#### ■ Uses:

Dry plasma cutting  
to immersed plasma cutting.  
(according to plasma installations).



#### Main features:

- Dual-motor drive system on the longitudinal axis ensures constant performance quality at any speed
- A range of suitable cutting speeds from 0 to 10 m/min.
- A 15 m/min range of travel speeds
- A single supplier for all equipment:
  - Machine, generator, torch, tool holder, height servo-control,
- High-performance options for steel plate marking and environmental protection,
- Torch shock protection on all versions of the NERTAJET HP
- Single or multi-torch available for enhanced productivity.

Oxytome / Plasmatome	15	20	25	30	35	40	50	60	65
Standard structure									
Reinforced structure (RS)									

## Options and add-ons

### ■ Plasma tool holder

The rugged design tool holder is capable of traveling 250 mm, thus allowing plasma arc cutting of materials in all conditions (immersed or dry): Immersed cutting is only possible using CPM 250, 300 and 720 torches in perfect safety.

The A.C.S. is fitted on a parallelogram guide system. When necessary, it can be retracted using the control panel. This means that the operator can monitor the cutting quality without damaging the environment. The electronic sensor ensures a constant distance between the nozzle and the steel plate, regardless of the cutting speed and without coming into contact with the workpiece.



### ■ Oxycutting tool holder

Electric tool holder with 150 mm travel.

### ■ Control panel

This panel contains all the functions required to remote control the cutting process. The plasma unit manages the process controls, the interface

with the digital controller and the height servo-control functions required to guarantee quality cutting and the service life of the wear parts.



### ■ Pilot gas control table

This ensures continuous adjustment of the gas as required without the need for operator monitoring or intervention by the operator.

### ■ Reinforced structure for Plasmatome (RS)

For plates wider than 4m or for certain equipment, a reinforced structure is used to ensure movement stability and precision.



# OXYTOME HPC



The OXYTOME range of oxycutting or plasma cutting machines combines the features required to implement your desired application: oxycutting, plasma cutting or marking processes. The OXYTOME range fitted with the HPC DIGITAL PROCESS controller automatically manages the flame cutting and/or plasma cutting and/or plasma marking processes.



- The OXYTOME HPC 20, 25, 30, 40 range or the OXYTOME RS HPC 30, 40, 50 and 65 range

**with reinforced structure provides the degree of automation required for your applications.**

#### **Rational use**

**of the NERTAJET HP plasma cutting process can be achieved by fitting it with an optional dual drive system.**

- With the HPC DIGITAL PROCESS gas control features, you are sure of continuous gas control without the need for operator monitoring.

- Each blowtorch is fitted with a set of warm-up solenoid pilot valves to speed up the process.
- Rationalized gas control: to prevent maladjustments in the blowtorches and reduced gas consumption

- Electric tool holder with 150 mm travel. Reduces operator interventions, thus limiting the risk of perpendicularity errors.
- Capacitive sensor: ensures tool holder automation and continuous monitoring of the cutting height. The small-diameter tilted edge capacitive sensor and the igniter are retracted when starting a cut in the center of a plate and are thus protected. When the tool holder is in the raised position, the capacitive sensor provides torch shock protection during high-speed movements.





Oxytome	15	20	25	30	35	40	50	60	65
Standard structure									
Reinforced structure (RS)									

• **Automatic gas control via a control panel for each blowtorch:**

- Controls cutting oxygen, heating oxygen and fuel gas pressures
- Optimized heating and overheating makes for reduced cutting times
- Reduced heating/overheating transition time regardless of the number of blowtorches used
- Precise flame adjustment for each blowtorch
- Identical adjustment and operation when operating with one or more blowtorches
- Exhaust-free regulation valve for safety
- Electrical ignition and detection

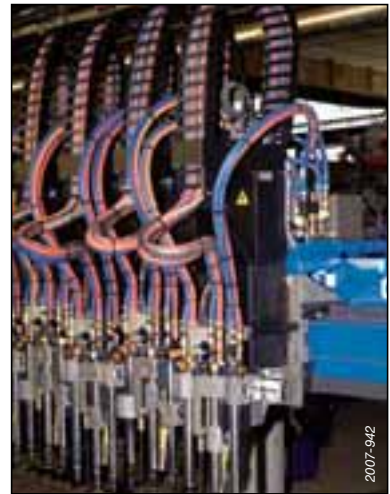

• **HPC DIGITAL PROCESS oxy-cutting control**

- Sets parameters
- Creates a customized database (for new material, optimized parameter settings, possibility of using two different cutting qualities on the same workpiece)
- Creates JOBS to memorize the cutting parameters and the parameters of the workpiece

# Options

Specific options for OXYTOME and OXYTOME HPC ranges The OXYTOME range has a wide choice of options, providing the cutting professions with a whole variety of possibilities to suit their applications.

## ■ Tapering system



## ■ Narrow strip cutting system



Capable of cutting strips from 80 to 155 mm wide, using independent blowtorches to give a better quality cut.

## ■ V X K axis straight beveling system



For bevels parallel to the axes using mechanical proximity sensors.

## ■ Oxycutting equipment



The standard machines are designed to take 6 blowtorches (8 available on option).

## ■ Tool holder PO 150 HPC with capacitive proximity sensor



# Common options

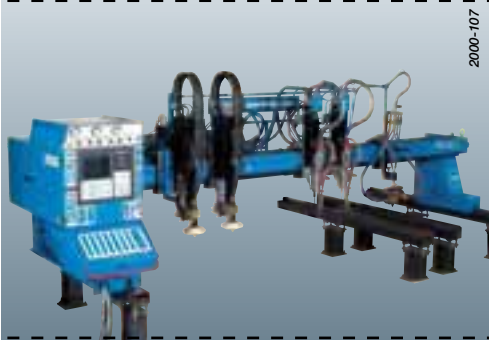

The OXYTOME and PLASMATOME ranges have a wide choice of options, providing the cutting professions with a whole variety of possibilities to suit their applications.

## ■ Automatic indexing

The arrival of automatic indexing has encouraged an upward trend in multi-torch applications. This option uses the digital process control to adjust the spacing between torches. This means that the machine can be programmed to cut identical parts or one-off parts without the need for operator intervention. This option also allows entirely automatic use of a machine equipped with 2 identical or 2 different accessories.



## ■ Mechanical drill

The rugged design of the PLASMATOME and OXYTOME machines allows them to support an optional mechanical drilling head.



This system uses a pneumatic drill mounted on a pneumatic slide rail with a travel

of 250 mm. A pressing system holds the steel plate in place during drilling. The maximum PCD is 6 mm with a drill or centering bit.

Note: If you require a drilling/marketing capability, please contact us.

## ■ Mechanical A.C.S.

The use of high plasma arc devices

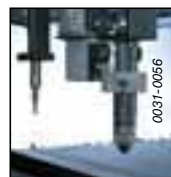

calls for the use of suitable A.C.S., ALW has developed a system capable of operating in all positions and in all situations

(immersed cutting or dry cutting) and that guarantees that the torch returns to its perpendicular position after the safety system has been tripped.

## ■ Fume extraction

On option, the machine can be equipped with a fume extractor above



the torch. This system is designed to extract fumes, in particular during immersed cutting.

The extractor is fitted with torch shock protection. A fume collector with lip seal is fitted on the machine. A second collector can be fitted along the track to evacuate fumes to the outside.

## ■ Emergency stop cable

Can be used to trigger an emergency stop from any point within the



operating area of the machine. There is a cable at the front and at the rear of the machine.

## ■ Home point

(not shown) Used

as a reference point from which all programs are started.

## ■ A.C.S.

Used if 2 or more machines are traveling on the same track.

## ■ Power harness installation (not shown)

On option, the power harnesses can be positioned either:

- Overhead,
- On the driven rail side.

In both cases, the machine is equipped with a dual drive system.

## ■ Cantilever beam

Allows side cutting.

## ■ Other options

Available on request.





# Plasma arc equipment



2006-519

## Power Sources

DC power sources are used. All automatic plasma power sources are of electronic “transistorized chopper” technology and providing superior performance thanks to the ability to react simultaneously with the cutting arc to ensure total cutting stability.

Generator	Current range	Torch
<b>1</b> NERTAJET 50	20 to 150 A	CPM 15
<b>2</b> HP 125	15 to 120 A	OCP 150
<b>3</b> HP 300	30 to 300 A	CPM 300
<b>4</b> HP 300	80 to 300 A	CPM 360
<b>5</b> HP 420	80 to 400 A	CPM 360
<b>6</b> HP 600	30 to 600 A	CPM 720
<b>7</b> HP 720	30 to 720 A	CPM 720



## Torches:

### **1** CPM 15 torch

For use on the NERTAJET 50.

### **2** OCP 150 torch

For use on the NERTAJET HP 125. Single or two-torch assemblies available.

### **3** CPM 360 torch

For use on the NERTAJET HP 300 and HP 420. Single or two-torch assemblies available.

### **4** CPM 300/720 torch

For use on the NERTAJET HP 300/720. Single or two-torch assemblies available.



**8**

0031-055



**9**

0255-044



**10**

2004-522



**11**

0823-060

# Plasma options

## ■ Plasma beveling system



### Longitudinal

This system allows the operator to manually tilt the torch in order to work plasma bevels along the longitudinal axis.

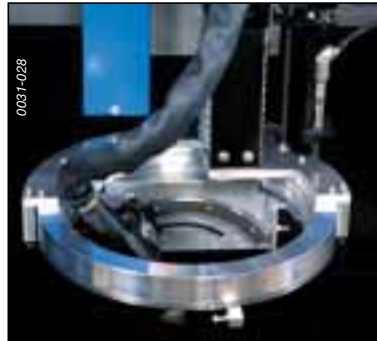

### Straight

This system is used to work bevels along 2 axes using a plasma torch. For further details on this option, please contact us.



### Open-ended

System rotation and tilting are entirely servo-controlled by the digital process controller which makes it possible to program a bevel angle change during a run. This light but rugged system guarantees excellent cutting results.

## MARKING

Five markers are available to suit your application:

### ■ Powder marking

Deposits grey zinc powder using an oxy/gas flame (for use only with the gas control panel)

### ■ HF marker pen

This pneumatic vibrator engraves sheet metal by slightly scoring the surface finish. Recommended for use on thin plates.

### ■ Felt-tip marking

Gravity-operated felt tip for marking stainless steels and light alloys. It operates by gravity and does not alter the surface finish of the material.

### ■ Pneumatic marking

For punching or engraving plates. The depth of marking is controlled by varying the compressed air pressure and the speed. Recommended for use on plates thicker than 5 mm.

### ■ Plasma arc marking

Low-power plasma arc for engraving or tracing on all materials. The depth of marking is controlled by the plasma arc power. The height is servo-controlled by the arc voltage.

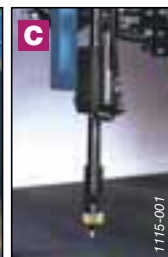

# ALPHATOME DIGITAL PROCESS



An alternative to laser cutting, high-performance plasma arc cutting using the **ALPHATOME DIGITAL PROCESS** is the cost-effective solution for plasma cutting of non-alloy steel, stainless steel or light alloy plates. Gives precise cuts, particularly recommended for thicknesses of 0.5 to 25 mm.

## The ALPHATOME fully exploits all the capabilities of the NERTAJET HP:

- A brushless drive system,
- Transverse and longitudinal guide system by recirculating ball bearings and slides,
- A high-inertia longitudinal track,
- High-performance path control by the HPC digital process.

## The combination of these techniques endows the NERTAJET HP with:

- Perfect path control,
- Perfect match between machine movements and the plasma process,
- On-going effort to achieve the optimum conditions required to ensure very high cutting quality,
- Positioning accuracy of +/- 0.1 mm.

## ■ Installation NERTAJET HP 125 with OCP 150 torch

Multi-process oxygen, argon/hydrogen, nitrogen water vortex DUALGAZ system features:

- Torch with removable and interchangeable tip that does not trigger HF's when striking arcs,
- Power range adjustable from 15 to 120 A,
- Moderate noise level.







### ■ Installation NERTAJET HP 300/HP 420 with CPM 360 torch

This multi-process DUALGAZ system is capable of high-performance cutting of non-alloy steels, stainless steels and light alloys.

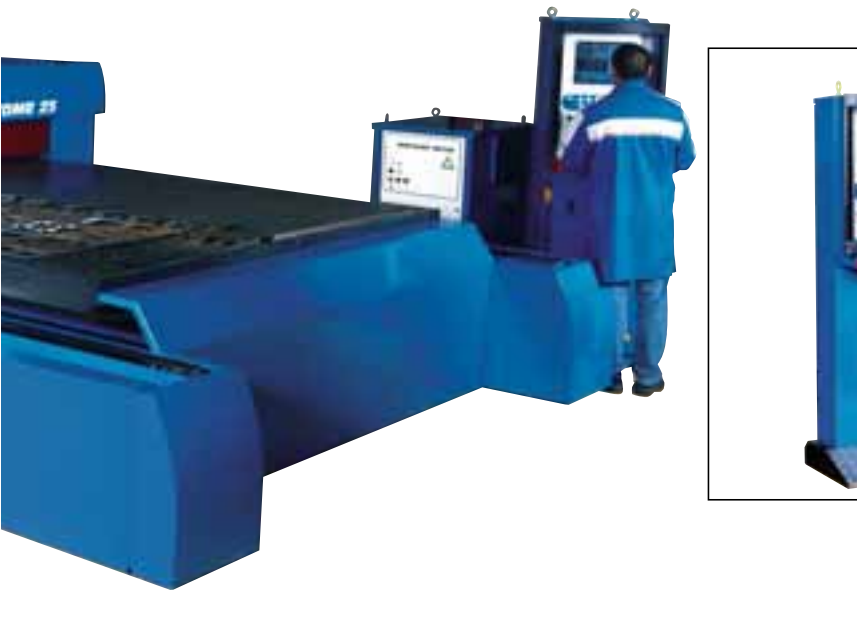

### ■ HPC DIGITAL PROCESS control panel

This control panel supports all of the machine's functional controls. It can be positioned as required to suit the type of machine used.

### ■ PO 150 tool holder

With 150 motorized travel, A.C.S. system also offering visual protection, its guidance concept and its reaction speeds adapted to NERTAJET HP plasma cutting, this tool holder is the ideal high-performance instrument for controlling the OCP 150 or CPM 360 torch height.

Its electronic sensor system measures the arc voltage to ensure the best position for optimum cutting quality throughout the cycle.

# Digital controls



The development of microprocessors has made it possible to group together all the components of a digital controller in a small space. The D 2.5+, 510 or 610 controllers integrate perfectly into the Air Liquide Welding machines to provide even better accuracy, productivity and return on investment.

## D 2.5+

Generates 50 selectable shapes and can be connected to a programming software through a serial link.



## D 510

Digital controller built around an open-ended PC architecture with Windows based movement control software



for enhanced performance and extremely high-performance multitasking operation. A touch-sensitive flat LCD screen provides access to a user-friendly man-machine interface, all controlled by a Pentium processor. Using the 50 standard shapes and the latest communication modes, the D 510 is a digital controller perfectly suited to automated cutting applications.

## D 610

This digital controller developed under Windows integrates a sophisticated path algorithm that ensures dynamic, real-time



path and I/O control. The high-performance, user-friendly man-machine interface integrates a high-quality touch-sensitive screen that provides access to the main control functions of the digital-control cutting machines. Management of the 50 standard shapes, in particular the innovatory and diversified I/O management, further enhances its performances. The D 610 is also one of the key functions in thermal cutting processes. It comes with a high-performance touch-sensitive screen.

**This new plasma cutting machines control concept has been specially created for easier workshop integration of modern, state-of-the-art machines implementing the latest features in plasma cutting of all electrically conductive materials, non-alloy and low-alloy steels, stainless steels and light alloys.**

**The HPC DIGITAL PROCESS operates under Windows 2000 installed on an industrial computer. The system features: the digital controller, the process control, the man-machine interface, a touch-sensitive screen and a control panel for all startup and emergency stop operations.**

### ■ Easier workshop integration means:

- The benefits of a tool adapted to your various cutting work, specially designed as an operator support
- Simple implementation of the plasma cutting machine,
- The benefits of a modern, innovatory, user-friendly design.

The Air Liquide Welding HPC DIGITAL PROCESS concept provides you with an intuitive and interactive means of accessing all our plasma and/or flame process expertise, as well as integrating and backing up your own expertise for retrieval by the various users. This system is organized and structured so that it can be operated by different members of your staff, even if they do not have in-depth understanding of the plasma process.



### ■ High-performance management

Quality cutting requires fast and efficient control of paths and programs, plus a multitasking capability. This function is provided by the digital control part of the HPC DIGITAL PROCESS.



### ■ Applications

The HPC DIGITAL PROCESS system is used mainly with OXYTOME/PLASMATOME and ALPHATOME cutting machines to control NERTAJET HP 125/HP 300 plasma cutting units fitted with OCP 150/CPM 360 torches. HPC DIGITAL PROCESS process management can be programmed to automatically combine plasma and/or flame cutting operations with plasma marking on the same plate.

All cutting machine users will benefit from HPC DIGITAL PROCESS.

The purpose of this system is to store your parameters, assist your operators, enable use by personnel without special training and increase the availability of your installations.





# OXYCUT/NERTAJET 50

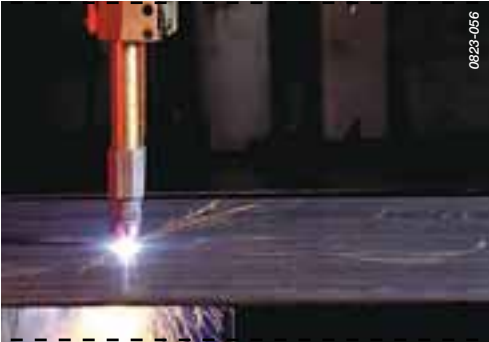

0829-066

- **OXYCUT** : a range of equipment suited to all automatic and semi-automatic oxy-cutting applications. OXYCUT blowtorches and tips can operate with all types of fuel gases: acetylene, propane, natural gas, tetrene, etc...
- **NERTAJET 50** : a multi-gas plasma cutting system.

## OXYCUT, oxy-cutting equipment (blowtorches + tips)

### Standard equipment

OXYCUT G1 blowtorches are designed to operate with cutting gas mixer heads. Rugged and reliable, they ensure high-quality work on plate thicknesses ranging from 3 to 300 mm.

### Thick plates

OXYCUT G2 is designed to work on plate thicknesses of up to 900 mm. Thanks to its cooling system, it is capable of operating in the most extreme conditions.

### MACH equipment

OXYCUT MACH is an internal-mix blowtorch. It operates with MACH-OXY tips to guarantee operating versatility and high-quality cutting. With reduced gas consumption and high cutting speeds, MACH-OXY equipment is very economical. The tips can be fitted on any type of blowtorch and require only 1 adaptor for each application.

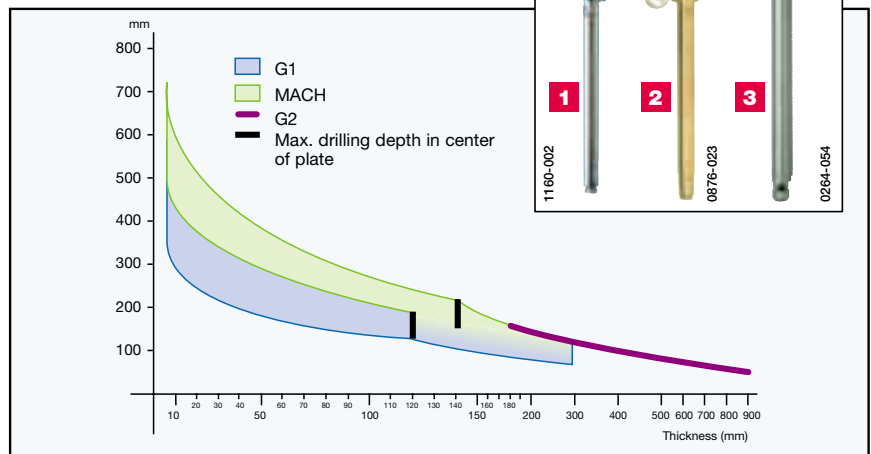

## NERTAJET 50

### Operating ranges with the CPM 15 torch

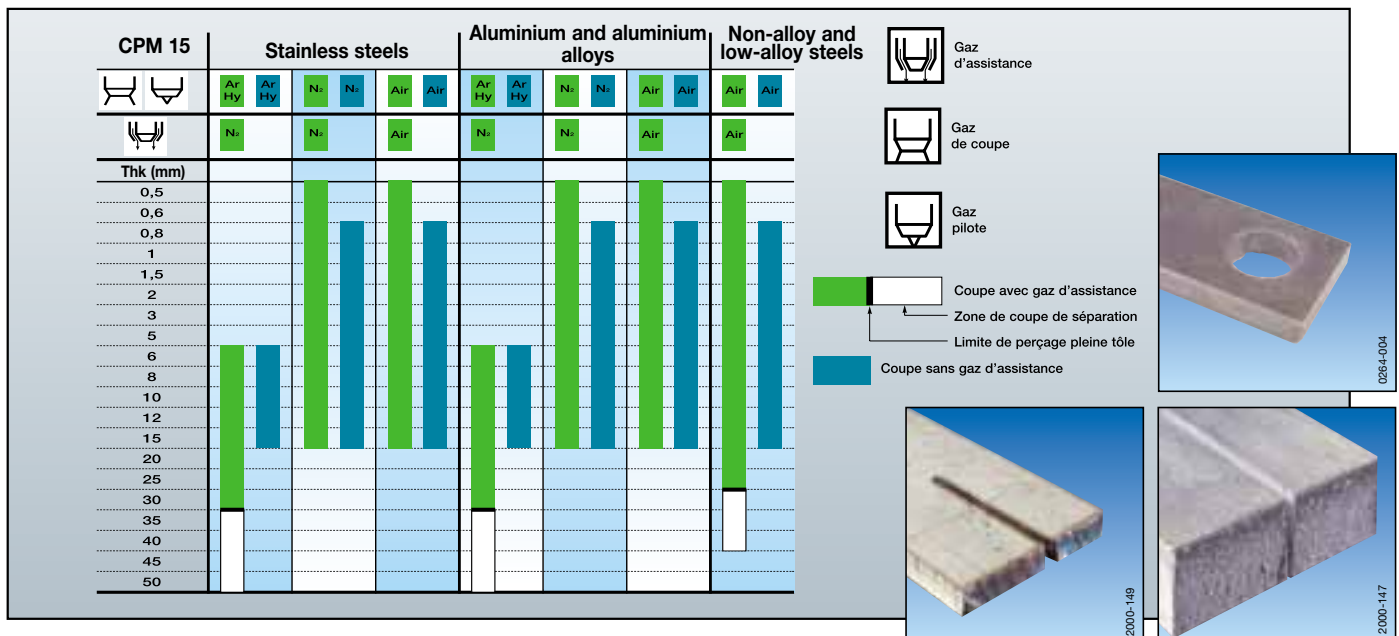

# NERTAJET HP

## Multi-process plasma cutting systems. NERTAJET HP systems operating range

O<sub>2</sub> = oxygen  
N<sub>2</sub> = nitrogen  
N<sub>2</sub> O<sub>2</sub> = industrial air  
Ar H<sub>2</sub> = argon - hydrogen

### Non-alloy and low-alloy steels

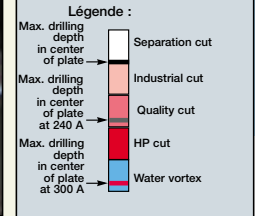
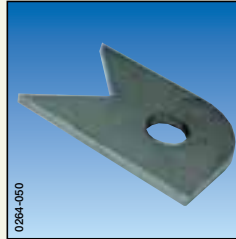
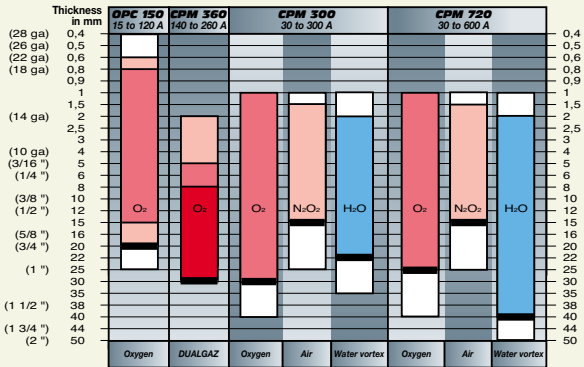

### Stainless steels

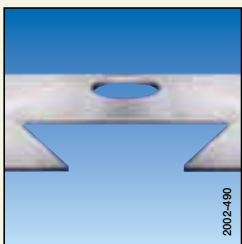
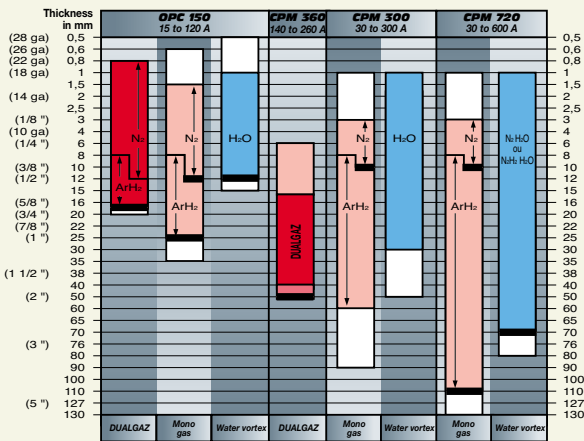

### Aluminium and aluminium alloys

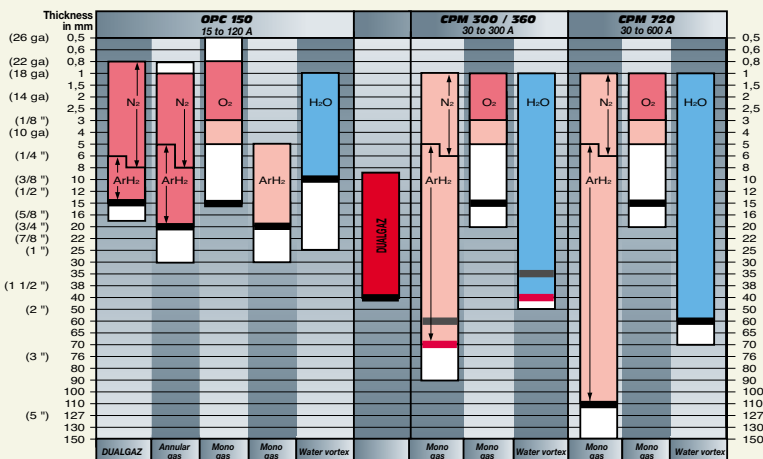

### Economic rating

The NERTAJET HP plasma cutting process lies between the oxycutting and the laser cutting processes in terms of machine investment, range of thicknesses to be cut and cutting quality. However, its fast cutting speeds provide the lowest operating costs (cost per meter of cut material).

### Comparative economic analysis between the plasma cutting process and the laser cutting process

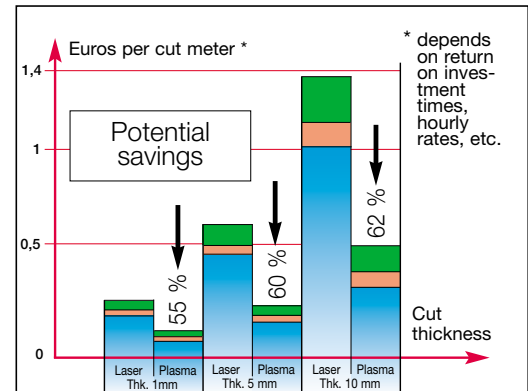

Legend:

- Consumables
- Programming + labor
- Equipment costs

### Cost-effectiveness rating

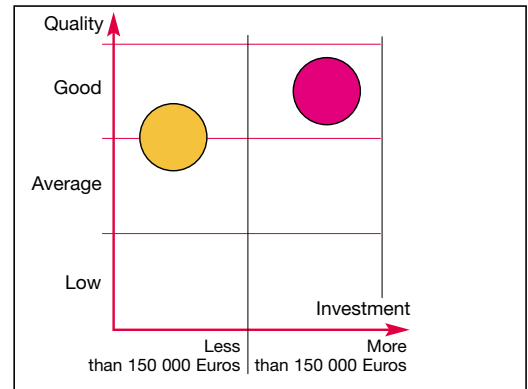

Legend:

- Laser
- Plasma



# CYBERTOME E: a large-width, high-



**Opens the way to all oxycutting and plasma arc cutting operations that require the use of machines capable of cutting very wide plates and implementing more complex options.**

## ■ The CYBERTOME range,

built around the machine tools concept to meet the most stringent operating criteria.

The available useful cutting widths range from 4 meters to 12 meters.

All versions are possible,

from 3 meters to 12 meters

in increments of 500 mm (other dimensions available on request).

The main feature of these machines is

their wide variety of useful widths; since

any tool holders not being used can be

parked on the parking track running along either side

of the cutting surface and installed either

behind the control panel,

or above the slave travel frame.

Particularly intended for large-scale cutting

projects, the CYBERTOME range can be

equipped on option with:

a drive system capable of reaching 30

m/min, whereas standard equipment

normally provides a speed of 15 m/min.

The quality of its high-inertia welded beam

means that this machine can be fitted with a very wide range of options to suit a large

variety of applications: multi-blowtorch,

multi-torch, plasma arc cutting with or

without beveling, mechanical drilling and

marking.

The CYBERTOME range is equipped with

a brushless drive system controlled by

digital VSDs to ensure dynamic operation

and quality movements that allow

oxycutting of thick plates at low speeds

and plasma arc cutting at high speeds.

The equipment can be equipped with the

following, depend on your needs:

- Up to 13 blowtorches for oxycutting
- Single or multi-torches for all NERTAJET HP 125, 300 and 360 range processes (others available on request)
- Mechanical drilling with a PCD ranging from 12 mm to 35 mm on request
- Different marking processes: pneumatic, plasma arc, ink jet
- Automatic indexing
- Angle or position-servo-controlled plasma or oxycut beveling according to specifications
- Flame control
- All other specific options.





# capacity cutting machine.

The beveling solution: the standard CYBERTOME version can be fitted with 1 or 2 beveling units. Thanks to its servo-control capabilities, it can control up to 4 units on request. Depending on your application, we can propose 5 different plate beveling solutions:

## ■ Mechanical drill

This option always provides one drilling unit per machine.

Depending



on the applications, you can drill locating holes or through-holes. The drill is either electric or pneumatic and is positioned by an electric or pneumatic slide rail. The standard PCD is 12 mm. On option, we can equip the CYBERTOME range with a drill capable of drilling up to 35 mm PCD, or with a multi-function unit equipped with drilling, tapping and countersinking heads.

## ■ Plasma arc beveling

*We can propose all types of solution depending on the bevels to be worked.*

### • Unidirectional beveling unit :

This equipment can work bevels using a plasma torch parallel to the machine axes, in the direction programmed by the digital controller. The angle is adjusted manually using mechanical stops.



### Bi-directional beveling unit:

This unit can work bevels using a plasma torch along the machine X or Y axes.



The quarter-turn rotation is driven by the digital controller. The angle is adjusted manually by means of mechanical stops, thus ensuring angle reproducibility and programmable selection of the bevel type.

### Variable plasma beveling unit

System rotation and tilting are entirely servo-controlled by the digital process controller, which makes it possible to program a bevel angle change during a run. This particularly light but sturdy unit guarantees excellent cutting and can be adapted to suit all types of application.

# AZURMATIC : 3 different solutions

## ■ Extraction table for dry cutting



The AZURMATIC table with air extraction offers unrivalled efficiency in terms of smoke removal thanks to its unique system of transverse extraction ducts. This sturdy one-piece or modular design table is divided lengthwise into 1-meter wide sections, so that extraction takes place over the entire width of the table but only on the module in operation. Mechanical grills actuated by the movement of the machine start up suction below the plate only at the point where cutting is taking place. This operating mode guarantees optimum extraction, regardless of the size of the plate to be cut, while still maintaining a moderate extraction air flowrate.

### Technical characteristics:

- Transverse duct extraction system
- Table divided lengthwise into 1-meter long sections (500 mm sections possible on request for intensive use)
- Removable slag pots
- Removable workpiece support frame with 100 x 6 mm section flat irons and 50 x 50 x 5 mm mesh grid
- Maximum capacity: plates up to 300 mm thick

## ■ Constant water level extraction table

Various processes, in particular plasma arc cutting with non-immersed water vortex, require a cutting table with water recovery and fume extraction. This table offers both possibilities.

This patented process avoids the need for filtering upstream of fume extraction.



### Technical characteristics:

- One-piece design divided into 630 mm sections
- Standard lengths: from 3 to 12 m
- Standard widths: 1.5, -2, 2.5 and 3 m,
- Height: 700, 800 or 920 mm,
- Maximum capacity: plates up to 50 mm thick

## ■ Variable water level tables

Variable water level tables are specifically intended for immersed



plasma arc cutting.

This procedure limits solid or gaseous pollution and protects against audible and visual aggressions.

It improves cutting accuracy while limiting distortion caused by heating of the workpiece.

### Technical characteristics:

- Modular design in lengths of 1.5, 1.75 and 2m
- Widths to demand
- Workpiece support frame swivels for quick, easy cleaning.

# Main characteristics

	A	B	C	D	D**
OXYTOME 20 HPC / PLASMATOME 20	2 950 mm	3 920 mm	5 520 mm	2 425 mm	1 625 mm
OXYTOME 25 HPC / PLASMATOME 25	3 450 mm	4 420 mm	6 020 mm	2 925 mm	2 125 mm
OXYTOME 30 HPC / PLASMATOME 30	3 950 mm	4 920 mm	6 520 mm	3 425 mm	2 625 mm
OXYTOME 40 HPC / PLASMATOME 40	4 950 mm	5 920 mm	7 520 mm	4 425 mm	3 625 mm
OXYTOME 50 RS* HPC / PLASMATOME RS* 50	5 950 mm	6 920 mm	8 520 mm	5 425 mm	1 125 mm
OXYTOME 60 RS* HPC / PLASMATOME RS* 60	6 950 mm	7 920 mm	9 520 mm	6 425 mm	4 625 mm
OXYTOME 65 RS* HPC / PLASMATOME RS* 65	7 450 mm	8 420 mm	9 920 mm	6 925 mm	2 625 mm
ALPHATOME 20	2 000 mm	3 200 mm	4 200 mm	-	-
ALPHATOME 25	2 500 mm	3 700 mm	4 700 mm	-	-
ALPHATOME 30	3 000 mm	4 200 mm	5 200 mm	-	-
ALPHATOME 40	4 000 mm	5 200 mm	6 200 mm	-	-

\* RS : Reinforced Structure

\*\* 5 PO on parking track

	OXYTOME HPC	PLASMATOME	ALPHATOME
<b>High speed</b>	15 m/min	15 m/min	22 m/min
<b>Operating speed for both ranges</b>	0 to 4 m/min for single-drive systems 0 to 10 m/min for dual-drive systems	0 to 10 m/min	0 to 10 m/min
<b>Max. number of tool holders</b>	8 blowtorche 6 blowtorches + 2 plasma torches	1 or 2 plasma torches	1 plasma torch (2 on option)
<b>Digital controller:</b>	choice of 4 types DIGISAF 2.5+, 510, 610 or HPC DIGITAL PROCESS		HPC DIGITAL PROCESS
<b>Dual drive</b>	on option for other standard widths	de base	
<b>Useful standard cutting length</b>	3 m		
<b>Additional length</b>	per 3 m and/or 1.5 m element		
<b>Marking (both depending on option)</b>	yes	2 (if two-torch option)	yes
<b>Positioning accuracy</b>	± 0,4 mm	± 0,4 mm	± 0,1 mm
<b>Electric ignition</b>	yes	no	no
<b>Capacitive sensor</b>	yes	-	-
<b>Detection</b>	yes	-	-
<b>Standard control gas</b>	de base	-	de base
<b>Cutting thickness</b>			
<b>Oxycutting</b>	2 blowtorches for 5 to 300 mm range 8 blowtorches for 5 to 80 mm range	-	-
<b>plasma cutting</b>	150 mm maximum	150 mm maximum	50 mm maximum
<b>Plasma equipment</b>	to demand	to demand	NERTAJET HP 125 / OCP 150 or NERTAJET HP 300 / CPM 360 or NERTAJET HP 420 / CPM 360

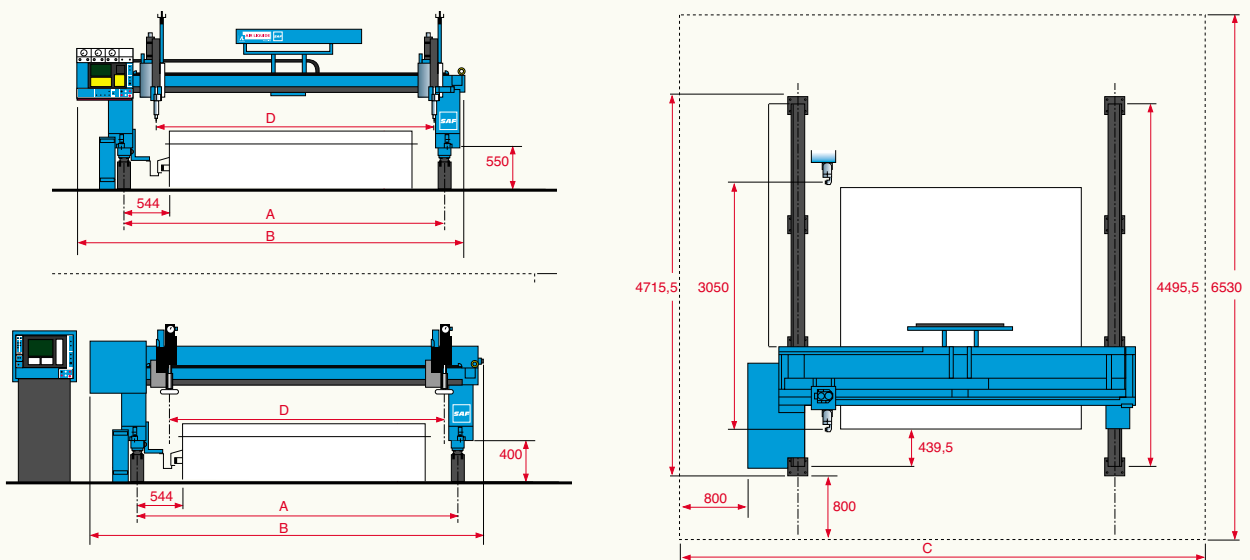



## Contacts

### BELGIUM

AIR LIQUIDE WELDING BELGIUM SA  
Z.I. West Gripen - Gripenlaan 5 - 3300 TIENEN  
Tel.: +32 16 80 48 20 - Fax: +32 16 78 29 22

### CHINA

SAF SHANGHAI REP. OFF.  
Rm. 722. Pine City Hotel  
777 Zhao Jia Bang Lu - SHANGHAI 200032  
Tel.: +86 21 64 43 89 69 - Fax: +86 21 64 43 58 97

### CZECH REPUBLIC

AIR LIQUIDE WELDING CZ S.R.O.  
Podnikatelská 565 - Areál SVUM  
190 11 PRAHA 9 - Búchovice  
Tel.: +420 274 023 163 - Fax: +420 274 023 233

### FRANCE

AIR LIQUIDE WELDING FRANCE  
13, rue d'Epluches - BP 70024 Saint-Ouen l'Aumône  
95315 CERGY PONTOISE Cedex  
Tel.: +33 1 34 21 33 33 - Fax: +33 1 34 21 31 30

### GERMANY

OERLIKON SCHWEISSTECHNIK GmbH  
Industriestrasse 12 - D-67304 EISENBERG/PFALZ  
Tel.: +49 6351 4760 - Fax: +49 6351 476 335

OERLIKON SCHWEISSTECHNIK GmbH  
Automationszentrum Schneider  
Christinenstrasse 25 - D-40880 RATINGEN  
Tel.: +49-(0)2102 -94216-0 - Fax: +49-(0)2166 -94216-91

### HUNGARY

AIR LIQUIDE WELDING HUNGARY - Kft  
Krisztina krt. 39/b - H-1013 Budapest  
Tel.: +36 1 339 8650 - Fax: +36 1 339 8649

### ITALY

AIR LIQUIDE WELDING ITALY  
Via Torricelli 15/A - 37135 VERONA  
Tel.: +39 045 82 91 511 - Fax: +39 045 82 91 536

### LUXEMBOURG

AIR LIQUIDE WELDING LUXEMBOURG S.A.  
5 rue de la Déportation - BP 1385 - L-1415 LUXEMBOURG  
Tel.: +352 48 54 56 - Fax: +352 48 54 57

### MALAYSIA

SAF-OERLIKON MALAYSIA SDN BHD  
No 10, Jalan TPP 5/1 - Taman Perindustrian Puchong  
47100 PUCHONG, SELANGOR  
Tel.: +603 8060 8638 - Fax: +603 8061 620

### NETHERLANDS

AIR LIQUIDE WELDING NETHERLANDS  
Rudonk 6 B - NL 4824 AJ BREDA  
Tel.: +31 76 541 00 80 - Fax: +31 76 541 58 96

### POLAND

AIR LIQUIDE WELDING POLSKA - SP. Z.o.o  
UL. Porcelanowa 10 - 40-246 KATOWICE  
Tel.: +48 32 609 04 50 - Fax: +48 32 609 04 60

### PORTUGAL

AIR LIQUIDE SOLDADURA LDA  
Rua Dr. António Loureiro Borges, 4-2º Arquiparque  
Miraflores - 1495-131 ALGÉS  
Tel.: +351 21 41 64 900 - Fax: +351 21 41 69 40

### ROMANIA

DUCTIL  
Aleea Industriilor Nr 1 - 120224 BUZAU  
Tel.: +40 238 722 058 - Fax: +40 238 716 861

### RUSSIA

AIR LIQUIDE WELDING  
17 Vorontsovskaya Str. - 109147 MOSCOW  
Tel.: +7 495 641 28 98 - Fax: +7 495 641 28 91

### SCANDINAVIA

OERLIKON SKANDINAVIEN AB  
Krossverksgatan 7 - 216 16 LIMHAMN  
Tel.: +46 (0)40 670 15 00 - Fax: +46 (0)40 670 15 01

### SLOVAKIA

AIR LIQUIDE WELDING CENTRAL EUROPE S.R.O.  
Prazska 35 - 94901 NITRA  
Tel.: +421 37 69 24 601 - Fax: +421 37 65 19 919

### SPAIN

OERLIKON SOLDADURA SA  
Poligono Industrial la Noria Carretera de Castellon  
Km-15,500 - 50730 El Burgo de Ebro - ZARAGOZA  
Tel.: +34 976 10 47 00 - Fax: +34 976 10 42 67

### SWITZERLAND

OERLIKON - SCHWEISSTECHNIK-AG  
Mandachstrasse 54 - CH 8155 NIEDERHASLI  
Tel.: +41 44 307 61 11 - Fax: +41 44 307 61 12

### THAILAND

AIR LIQUIDE WELDING THAILAND Co Ltd  
40 Moo 6 - Ramindra Road Km. 9.5  
KHANNAYAO, BANGKOK 10230  
Tel.: +66 2 9432250 - Fax: +66 2 9432256

### U.A.E.

AIR LIQUIDE WELDING MIDDLE EAST FZE  
Jebel Ali free zone warehouse No. FZS1AH05  
P.O. BOX 18734 - Jebel Ali - DUBAI  
Tel.: +971(0)48861606 - Fax: +971(0)48861608

### U. K.

AIR LIQUIDE WELDING Ltd  
Low March / London Road - DAVENTRY  
Northants NN11 4SD  
Tel.: +44 1 327 70 55 11 - Fax: +44 1 327 70 13 10

### UKRAINE

AIR LIQUIDE WELDING UKRAINE, Llc.  
1 rue Proskura - bureau 106A - 61070 KHARKOV  
Tel.: +380 577 546 867 - Fax: +380 577 546 867

## Contacts for other countries

### ALW Export Department Italy

Via Torricelli 15/A  
37135 Verona - Italy  
Tel: +39 045 82 91 511  
Fax: +39 045 82 91 536  
Email: export.alwitaly@airliquide.com

### ALW Export Department France

13, rue d'Epluches  
BP 70024 Saint Ouen l'Aumône  
95315 Cergy-Pontoise Cedex - France  
Tel: +33 1 34 21 33 33 - Fax: +33 1 30 37 19 73  
Email: export.alwfrance@airliquide.com

[www.oerlikon-welding.com](http://www.oerlikon-welding.com)



Founded in 1902, Air Liquide is the world leader in industrial and medical gases and related services. The company has offices in 75 countries and employs a work force of 40,000. Drawing on constantly renewed technologies, Air Liquide develops groundbreaking solutions used in making countless everyday products and in helping to preserve life.